

Article number: 03503045

Description: Fluro Rod end GE 45HO-2RS

Measures

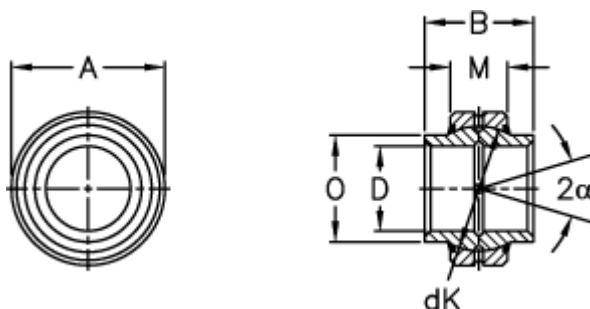

A	= 68 0 -0,013	Tilt angle = 3
B	= 40	Weight = 430
D	= 45 0 -0,012	
dK	= 60	
Dynamic load C (kN)	= 127	
M	= 25	
O	= 51.5	
Static load C0 (kN)	= 640	